













# R. C. Tronics Incorporated

2573 East Kercher Road  
Goshen, Indiana 46528  
Toll Free 1-866-457-7790

Phone 1-574-642-3857  
Fax 1-574-642-3858  
<http://www.rctronics.com>

RCT-01665-0\_\_01

## Molly Trolley

<p><b>OPEN</b> V8D1WXB-AF800 000-XRC1 / C-00019</p>  <p><b>DOOR</b></p>  <p><b>CLOSE</b></p>	<p><b>ON MAINTAINED</b></p>  <p><b>INTERIOR LIGHT</b></p> <p>V1D11XOB-AE800 -000-XRC1 / C-00013</p> <p><b>OFF</b></p>	<p><b>ON C-80014</b></p>  <p><b>WHEEL-CHAIR LIFT</b></p> <p>V1D11XOB-AE800 -000-XRC1 / C-00014</p> <p><b>OFF</b></p>	<p><b>NBL BLANK</b></p>
<p><b>ON MAINTAINED</b></p>  <p><b>EXHAUST FAN</b></p> <p>V1D11XOB-AE800 -000-XRC1 / C-00026</p> <p><b>OFF</b></p>	<p><b>HIGH MAINTAINED</b></p>  <p><b>FAN</b></p> <p>C-00177-10-V8D</p> <p><b>LOW</b></p>	<p><b>HIGH MAINTAINED</b></p>  <p><b>WINDOW DEFROST</b></p> <p>V6D1WPCB-AF800 000-XRC1</p> <p>C-00026</p> <p><b>LOW</b></p>	<p><b>HIGH MAINTAINED</b></p>  <p><b>DRIVER HEAT</b></p> <p>V6D1WPCB-AF800 000-XRC1</p> <p>C-00028</p> <p><b>LOW</b></p>
<p><b>HIGH MAINTAINED</b></p>  <p><b>MIDDLE HEAT</b></p> <p>V6D1WPCB-AF800 000-XRC1</p> <p>C-00027</p> <p><b>LOW</b></p>	<p><b>HIGH MAINTAINED</b></p>  <p><b>REAR HEAT</b></p> <p>V6D1WPCB-AF800 000-XRC1</p> <p>C-00027</p> <p><b>LOW</b></p>	<p><b>ON MAINTAINED</b></p>  <p><b>BELL</b></p> <p>V1D11XOB-AE800 -000-XRC1 / C-00027</p> <p><b>OFF</b></p>	<p><b>ON MAINTAINED</b></p>  <p><b>MASTER SWITCH</b></p> <p>V1D11XOB-AE800 -000-XRC1 / C-00002</p> <p><b>OFF</b></p>

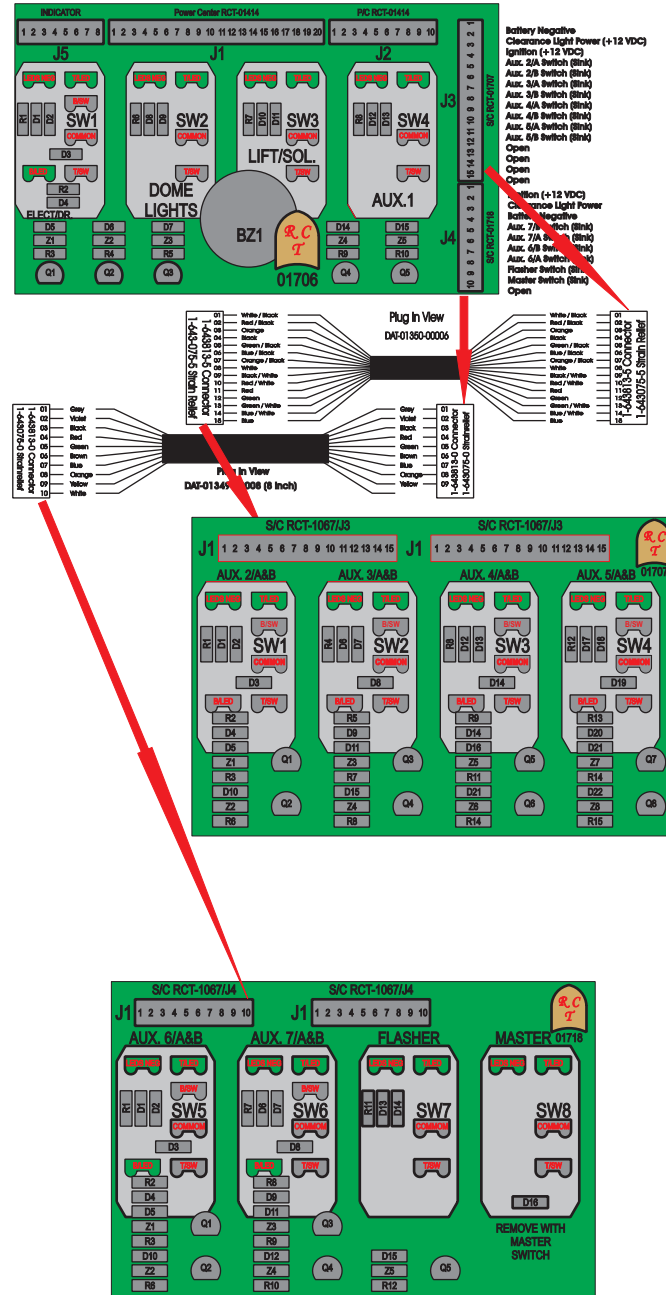

FAC-01665-00000